

## Appendix 1 – Lake Champlain Vessels

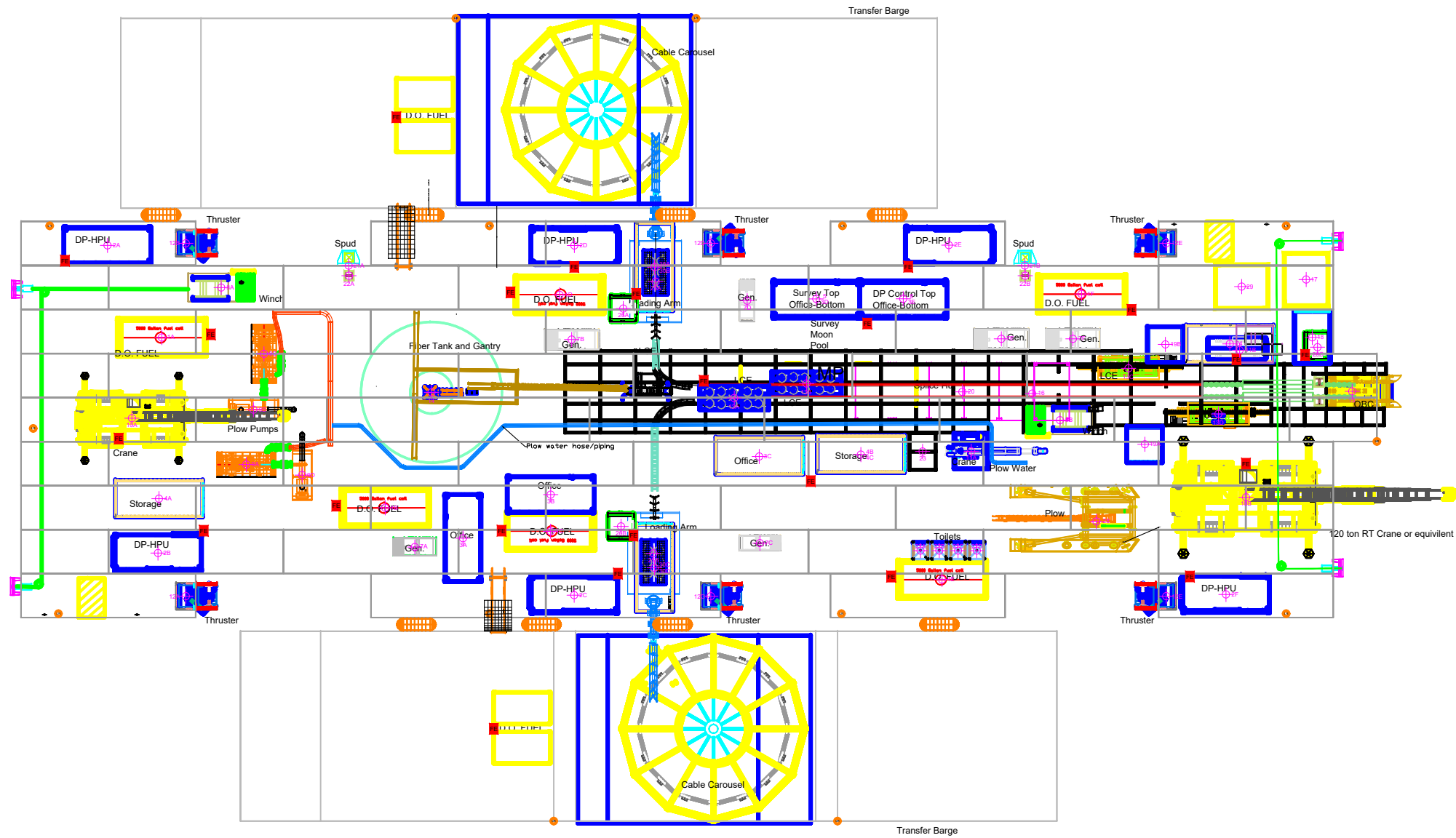

This document contains ideas and designs that are the property of Caldwell Marine International (CMI). Thus, the information is not to be used, in whole, or in part for any other project without written authorization of CMI.

<p><b>Caldwell</b> Marine International, LLC. 1333 Campus Parkway Wall Township, N.J. 07753 (732) 557-6100</p>		Project: <b>CHPE</b>	
		Drawing Name: <b>LAKE CHAMPLAIN INSTALLATION BARGE</b>	
		Client: <b>NK T</b>	
Drawn By:		Date Drawn:	05/23/23
Checked By:		Date Approved:	
Scale: 1/32" = 1'-0"		Sheet No.	1
		Rev.	

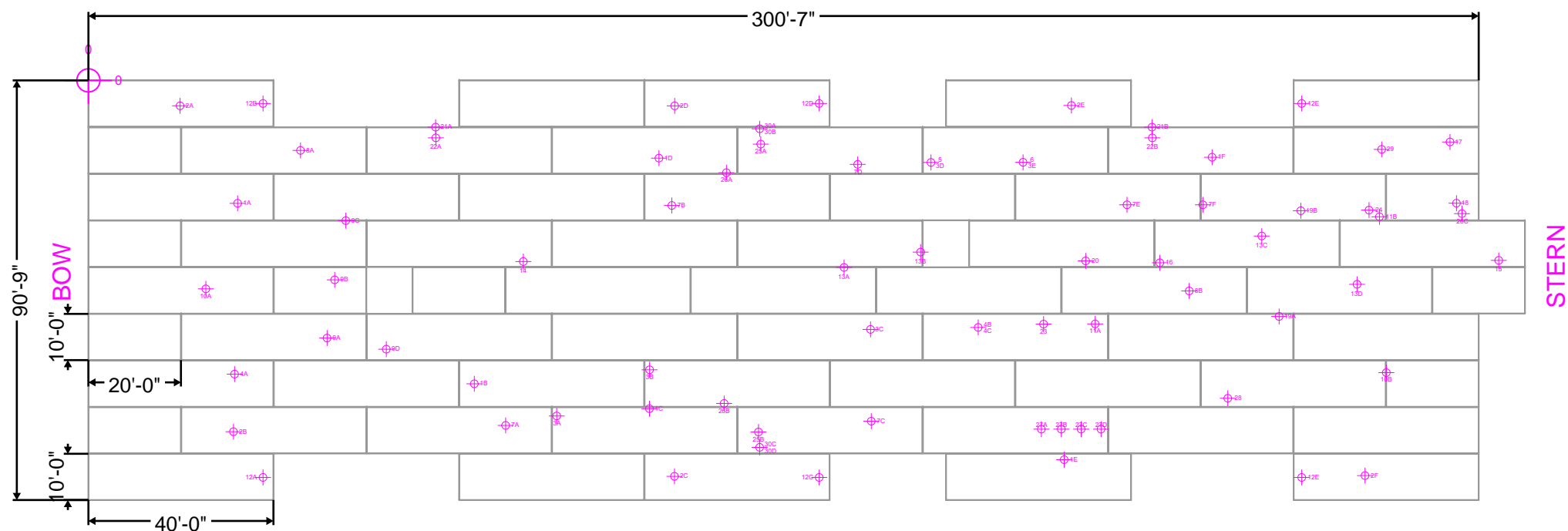

This document contains ideas and designs that are the property of Caldwell Marine International (CMI). Thus, the information is not to be used, in whole, or in part for any other project without written authorization of CMI.

<p><b>Caldwell</b> Marine International, LLC. 1333 Campus Parkway Wall Township, N.J. 07753 (732) 557-6100</p>		Project: <b>CHPE</b>	
		Drawing Name: <b>LAKE CHAMPLAIN INSTALLATION BARGE</b>	
Scale: $\frac{1}{32}'' = 1'-0''$		Client: <b>NK T</b>	
		Drawn By:	Date Drawn: 05/23/23
		Checked By:	Date Approved:
		Sheet No.	Rev.
		2	

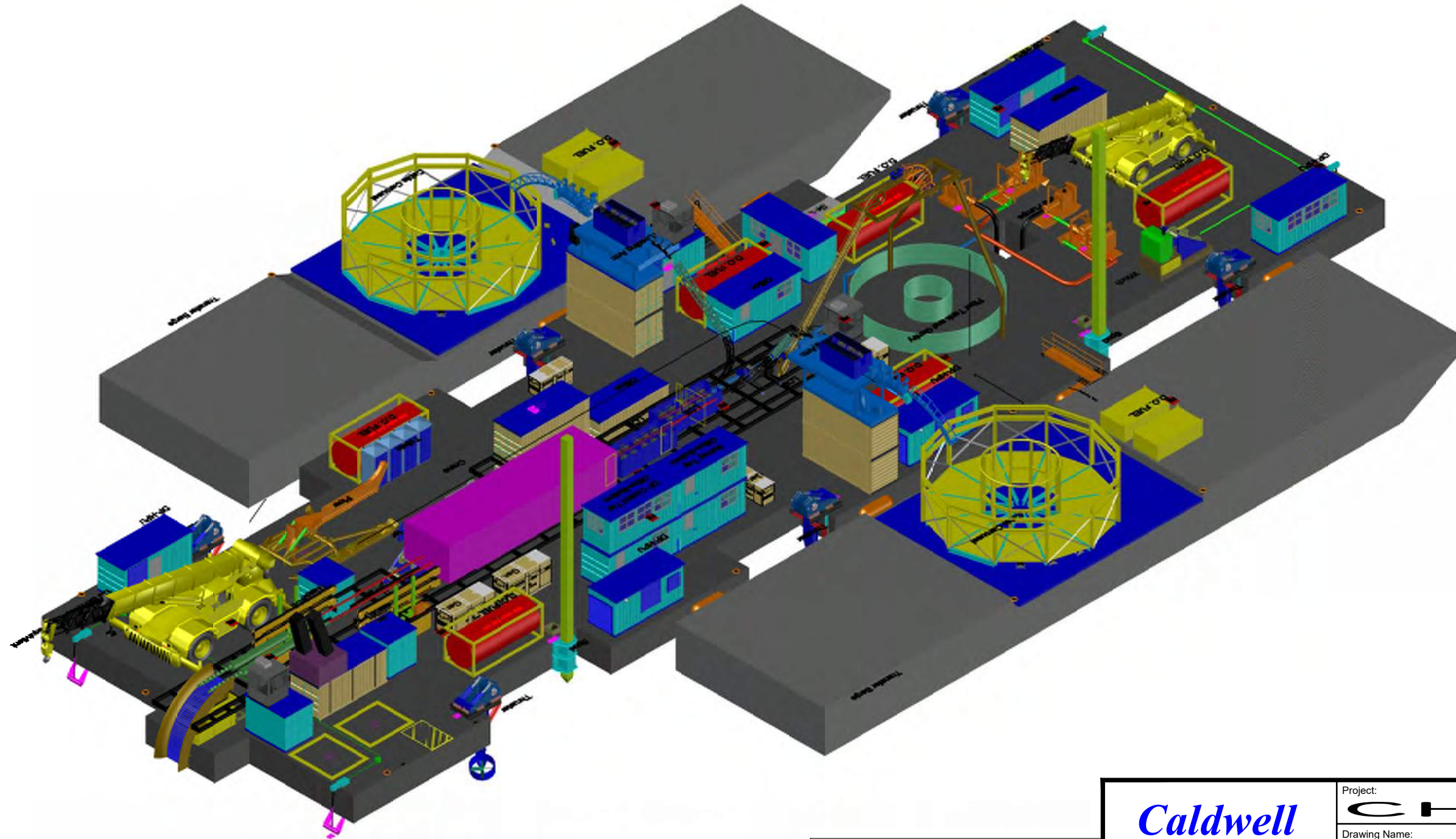

This document contains ideas and designs that are the property of Caldwell Marine International (CMI). Thus, the information is not to be used, in whole, or in part for any other project without written authorization of CMI.

 <b>1333 Campus Parkway</b> <b>Wall Township, N.J. 07753</b> <b>(732) 557-6100</b>		Project: <b>CHPE</b>	
		Drawing Name: <b>LAKE CHAMPLAIN INSTALLATION BARGE</b>	
		Client: <b>NK T</b>	
Drawn By: PEL		Date Drawn: 05/23/2023	
Checked By:		Date Approved:	
Scale: N/A		Sheet No. <b>3</b>	Rev:

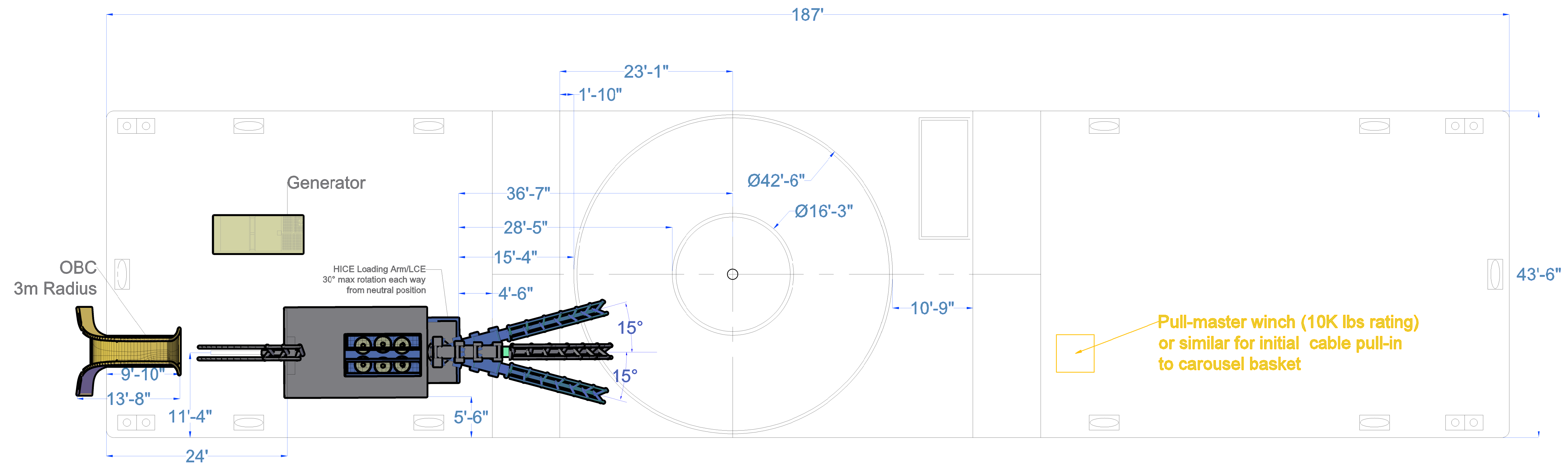

Pull-master winch (10K lbs rating) or similar for initial cable pull-in to carousel basket

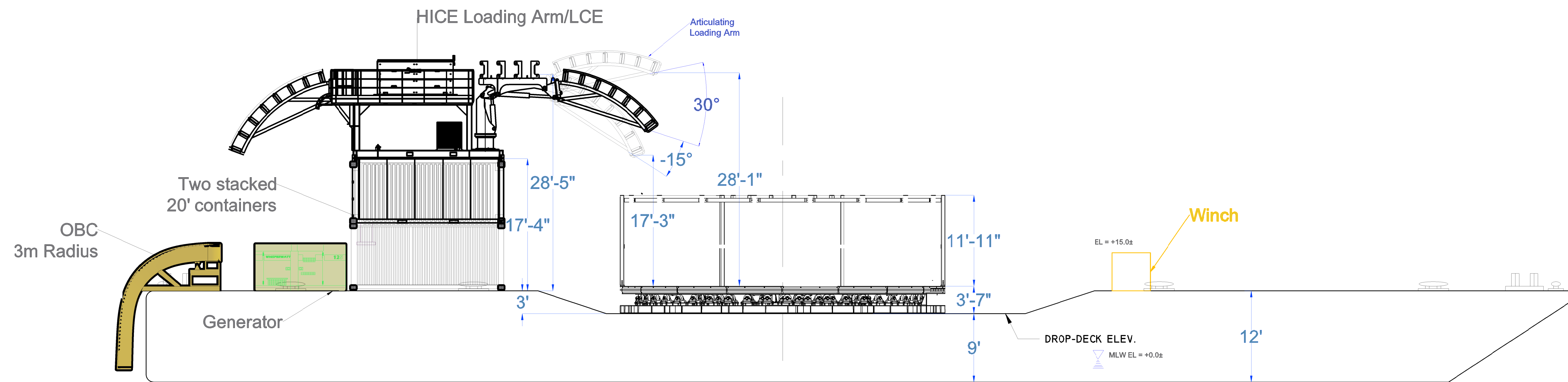

No.	REVISION	DATE	BY

This document contains ideas and designs that are the property of Caldwell Marine International (CMI). Thus, the information is not to be used, in whole, or in part for any other project without written authorization of CMI.

**Caldwell**  
Marine International, LLC.  
1333 Campus Parkway  
Wall Township, N.J. 07727  
(732) 557-6100

Project: Cable Transport Barge  
Client:

Drawn By: PL  
Approved By: GG

Date Drawn: 07-11-2023  
Date Approved: 08-15-2023

Project No.: 1233  
Scale: 1/8" = 1'-0"  
Sheet No.: 1  
Rev.: 0

RAKED BOW

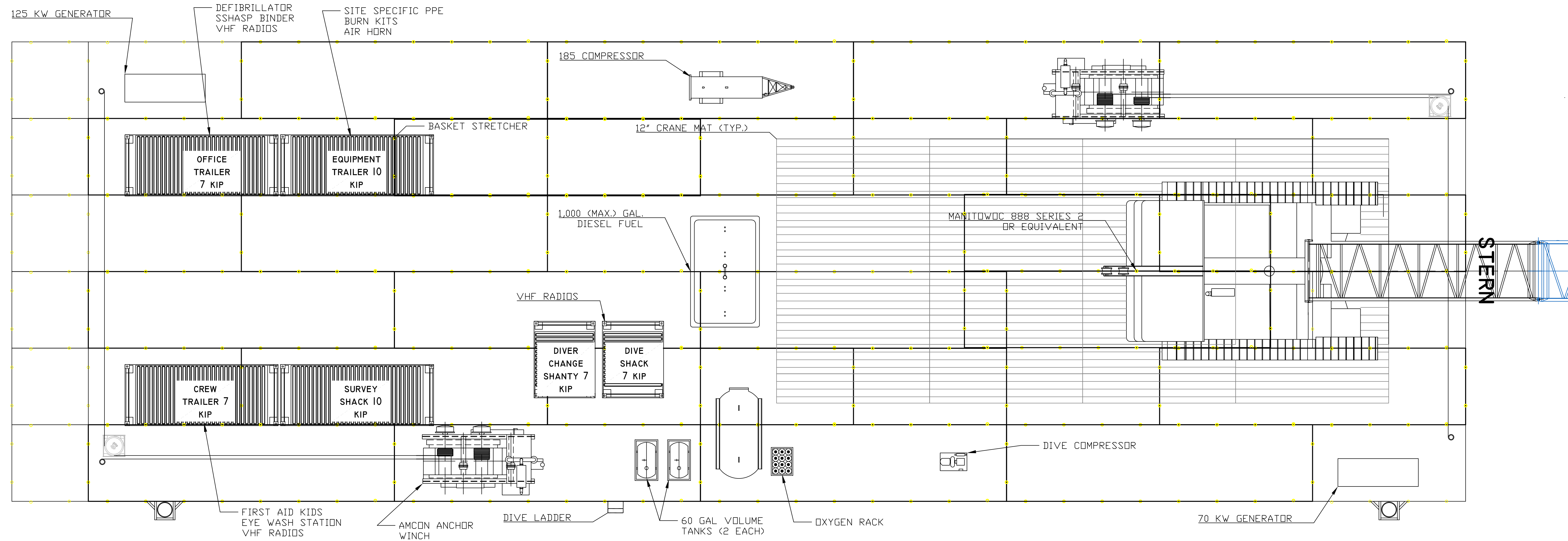

STERN

No.	REVISION	DATE	BY
1			

This document contains ideas and designs that are the property of Caldwell Marine International (CMI). Thus, the information is not to be used, in whole, or in part for any other project without written authorization of CMI.

**Caldwell Marine INTERNATIONAL**

1333 Campus Parkway  
Wall Township, N.J. 07753  
(732) 557-6100

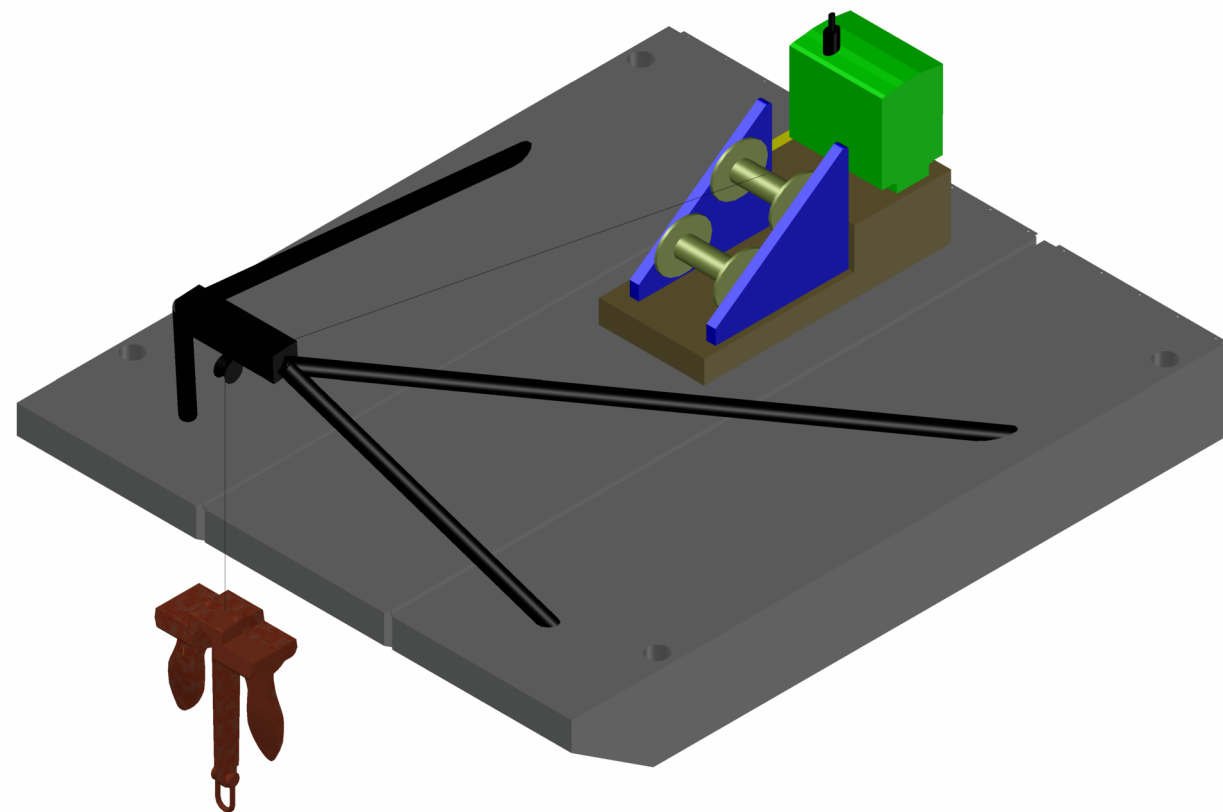
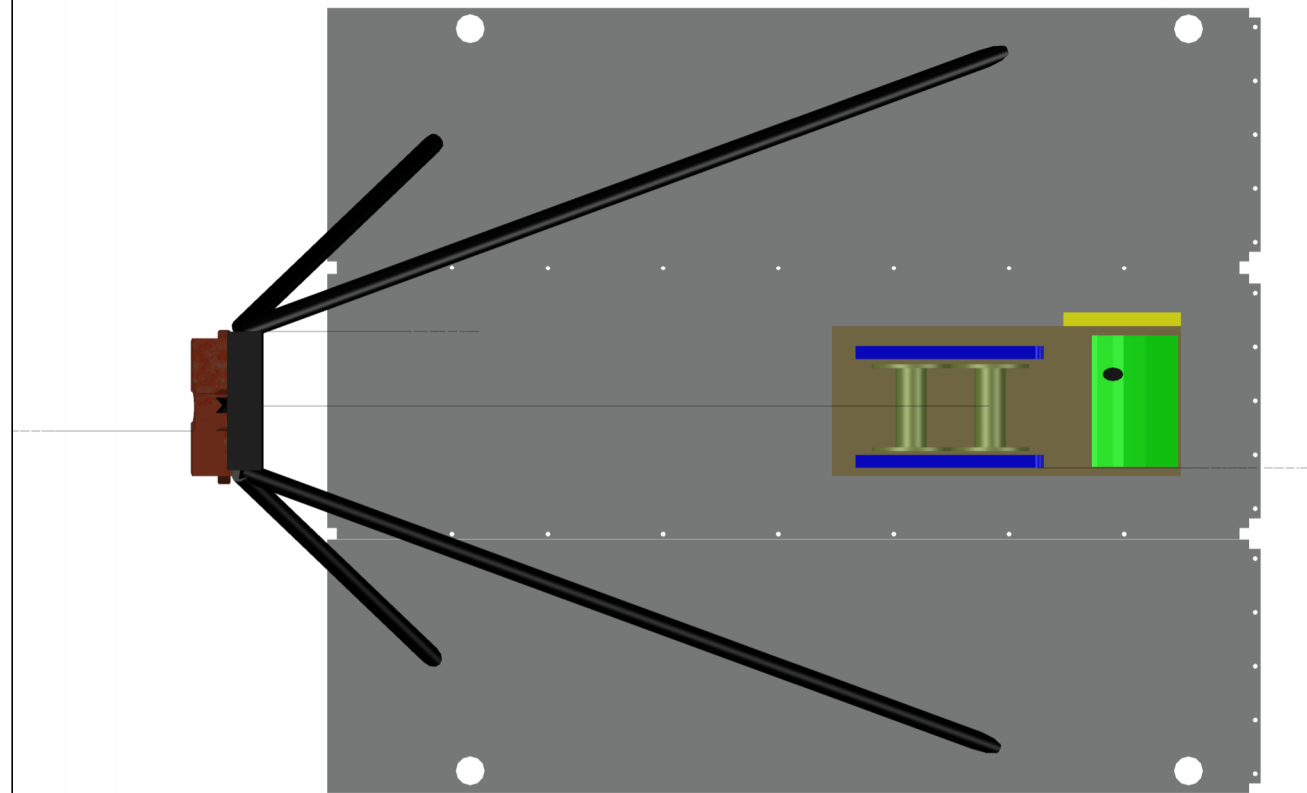
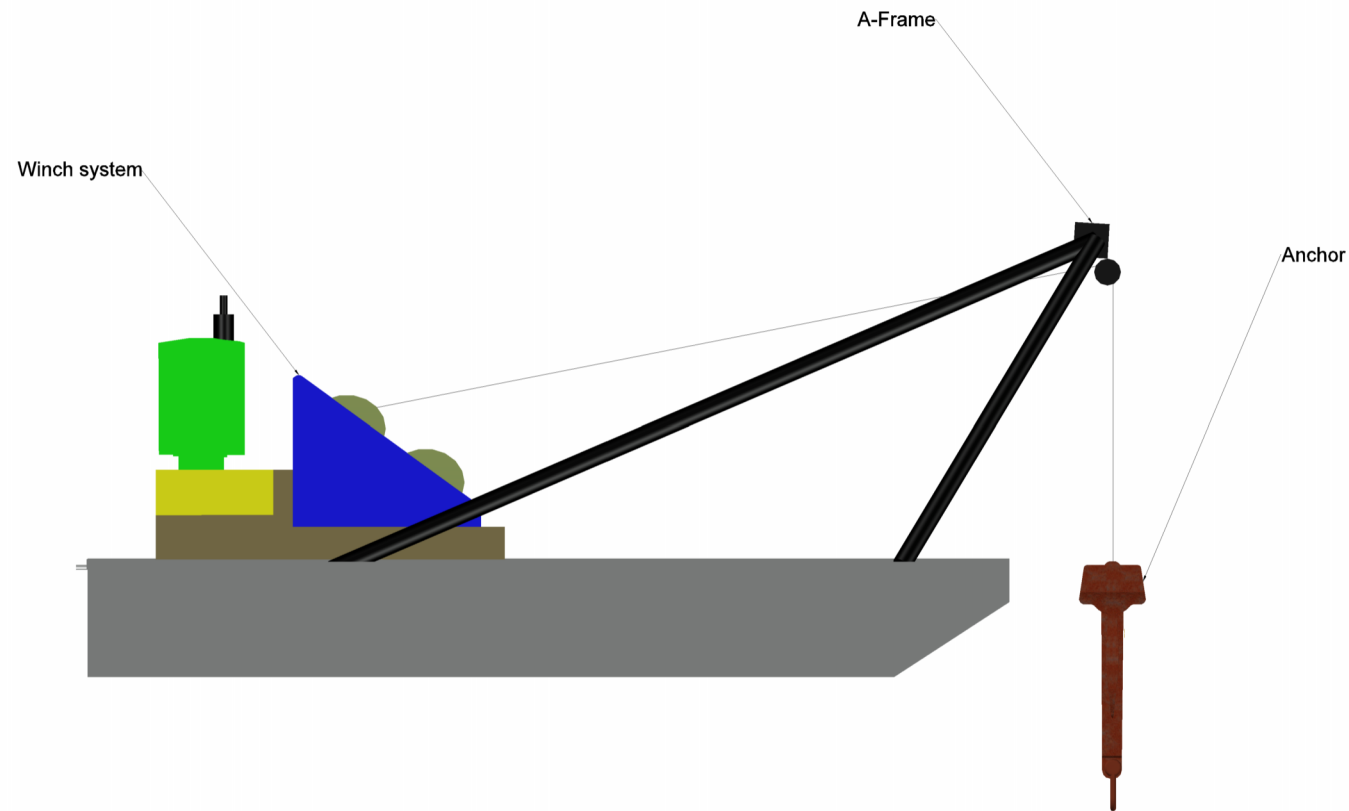

Project: CHPE LAKE CHAMPLAIN  
Drawing Name: CRANE SUPPORT BARGE DECK LAYOUT  
Client: DP  
Scale: 1/16" = 1'-0"

Drawn By:	DP	Date Drawn:	09/18/2023
Approved By:		Date Approved:	
Project No.:	1233	Sheet No.:	1/1
		Rev.:	0



NOTES:  
 ANCHOR SUPPORT BARGE:  
 40'L X 30'W X 5'D  
 EQUIPPED WITH A-FRAME AND DOUBLE  
 BARREL DRUM WINCH (OR SIMILAR) TO  
 HANDLE CABLE LAY BARGE AND/OR CRANE  
 SUPPORT BARGE ANCHORS  
 2 X SPUDS TO HOLD POSITION

This document contains ideas and designs that are the property of Caldwell Marine International (CMI). Thus, the information is not to be used, in whole, or in part for any other project without written authorization of CMI.

 <b>1333 Campus Parkway</b> <b>Wall, N.J. 07753</b> <b>(732) 557-6100</b>	Project: CHAMPLAIN HUDSON POWER EXPRESS	
	Drawing Name: <b>ANCHOR SUPPORT BARGE</b>	
Scale: <b>NTS</b>	Client: 	
	Drawn By: PL	Date Drawn: 2023-04-05
	Approved By: GG	Date Approved: 2023-10-06
	Est or Project No: <b>1233</b>	Sheet No. Rev: <b>1 0</b>

## CMI Equipment Crew Boat 'Alexis'

Vessel Name: 'Alexis'  
Vessel Type: USCG Inspected , mono-hull crew boat  
Propulsion: Twin screw powered by 2 x Caterpillar 3406E diesel engines  
Builder: Aluminum Boats of Virginia / Hull #102  
Year Built: 1998  
Official Number: 1073420  
Call Sign: WDA6065  
LOA: 55ft  
Beam: 16ft  
Depth: 7ft 3inches  
Gross Tonnage: 42  
Net Tonnage: 33  
Deck Space: 116 ft<sup>2</sup>  
Capacities: Persons -29 + crew  
Fuel – 2,200 US Gallons  
Hydraulic Oil – 10 US Gallons  
Nav Equipment: GPS & chartplotter, radar, AIS,  
Life Saving Appliances: Per USCG requirements







<b>Vessel Name:</b>	Benjamin Elliot
<b>Class:</b>	Harbor & Canal Tug
<b>Email:</b>	Tug_Ben@nysmarinehighway.com
<b>Mobile:</b>	518.832.3399
<b>Official Number:</b>	283659
<b>Port of Registry:</b>	Troy, New York
<b>Radio Call Sign:</b>	WDJ-4406
<b>Length:</b>	55
<b>Width:</b>	16
<b>Depth:</b>	9
<b>Gross Tons:</b>	27
<b>Main Engine:</b>	(2) Detroit 6-110
<b>Horsepower:</b>	640
<b>Generator:</b>	(1) Kubota 20 KW AC
<b>Fuel Capacity:</b>	2,000 US Gal.
<b>Lube Capacity:</b>	50 US Gal.
<b>Potable Water:</b>	700 US Gal.
<b>Berthing:</b>	3
<b>Electronics:</b>	(1) Radar, (3) VHF, AIS, GPS, Chart Plotter, Depth, (1) PC's, Printer, Internet, EPIRB
<b>Push Gear:</b>	(2) 20 Ton Face Winches
<b>Other Equipment:</b>	Portable Dewatering Pumps, Cutting, Welding Gear, Heat and AC



<b>Vessel Name:</b>	Edna D
<b>Class:</b>	Push Tug – Telescopic Wheelhouse
<b>Email:</b>	Tug_EdnaA@nysmarinehighway.com
<b>Mobile:</b>	518.391.5997
<b>Official Number:</b>	626166
<b>Port of Registry:</b>	Troy, New York
<b>Radio Call Sign:</b>	WDI-8538
<b>Length:</b>	53
<b>Width:</b>	22
<b>Depth:</b>	8.3
<b>Gross Tons:</b>	83
<b>Main Engine:</b>	(2) Detroit 1271
<b>Horsepower:</b>	1,000
<b>Generator:</b>	(2) Detroit 30 KW
<b>Fuel Capacity:</b>	8,600 US Gal.
<b>Lube Capacity:</b>	175 US Gal.
<b>Potable Water:</b>	5,000 US Gal.
<b>Berthing:</b>	4
<b>Electronics:</b>	(1) Radar, (2) VHF, AIS, GPS, Chart Plotter, Depth, (2) PC's, Printer, Internet, EPIRB
<b>Push Gear:</b>	(2) 20T Face Winches
<b>Other Equipment:</b>	Life Raft, Portable Dewatering Pumps, Cutting, Welding Gear, Washer, Dryer, Heat and AC



<b>Vessel Name:</b>	Frances
<b>Class:</b>	Coastal & Canal Tug – Retractable Wheelhouse
<b>Email:</b>	Tug_Frances@nysmarinehighway.com
<b>Mobile:</b>	518.527.0447
<b>Official Number:</b>	275588
<b>Port of Registry:</b>	Troy, New York
<b>Radio Call Sign:</b>	WDG-7506
<b>Length:</b>	85
<b>Width:</b>	24
<b>Depth:</b>	9.6
<b>Gross Tons:</b>	146
<b>Main Engine:</b>	EMD 16-567C
<b>Horsepower:</b>	1,800
<b>Generator:</b>	(1) Detroit 30KW DC , (1) Kubota 20 KW AC, (1) Shaft 25 KW DC
<b>Fuel Capacity:</b>	15,000 US Gal.
<b>Lube Capacity:</b>	350 US Gal.
<b>Potable Water:</b>	3,000 US Gal.
<b>Berthing:</b>	8
<b>Electronics:</b>	(3) Radar, (3) VHF, AIS, GPS, Chart Plotter, Depth, (2) PC's, Printer, Internet, EPIRB
<b>Push Gear:</b>	(1) Hydraulic Capstan
<b>Other Equipment:</b>	Life Raft, Portable Dewatering Pumps, Cutting, Welding Gear, Washer, Dryer, Heat and AC



<b>Vessel Name:</b>	Lucy H
<b>Class:</b>	Push Tug – Telescopic Wheelhouse
<b>Email:</b>	Tug_LucyH@nysmarinehighway.com
<b>Mobile:</b>	518.391.5997
<b>Official Number:</b>	617694
<b>Port of Registry:</b>	Troy, New York
<b>Radio Call Sign:</b>	WDI-8823
<b>Length:</b>	52
<b>Width:</b>	22
<b>Depth:</b>	9.6
<b>Gross Tons:</b>	88
<b>Main Engine:</b>	(2) Detroit 1271
<b>Horsepower:</b>	1,000
<b>Generator:</b>	(2) Kubota 30 KW
<b>Fuel Capacity:</b>	8,600 US Gal.
<b>Lube Capacity:</b>	175 US Gal.
<b>Potable Water:</b>	5,000 US Gal.
<b>Berthing:</b>	3
<b>Electronics:</b>	(1) Radar, (2) VHF, AIS, GPS, Chart Plotter, Depth, (2) PC's, Printer, Internet, EPIRB
<b>Push Gear:</b>	(2) 20T Hydraulic Face Winches
<b>Other Equipment:</b>	Life Raft, Portable Dewatering Pumps, Cutting, Welding Gear, Heat and AC



<b>Vessel Name:</b>	Maddie K
<b>Class:</b>	Harbor Tug
<b>Email:</b>	Tug_MaddieK@nysmarinehighway.com
<b>Mobile:</b>	518.
<b>Official Number:</b>	600676
<b>Port of Registry:</b>	Troy, New York
<b>Radio Call Sign:</b>	WDC-2864
<b>Length:</b>	73.3
<b>Width:</b>	24.3
<b>Depth:</b>	8.1
<b>Gross Tons:</b>	96
<b>Main Engine:</b>	(2) Cummins KTA38-M
<b>Horsepower:</b>	2000
<b>Generator:</b>	(2) John Deere 60 KW
<b>Fuel Capacity:</b>	28,000 US Gal.
<b>Lube Capacity:</b>	150 US Gal.
<b>Potable Water:</b>	1,000 US Gal.
<b>Berthing:</b>	5
<b>Electronics:</b>	(3) Radar, (4) VHF, AIS, GPS, Chart Plotter, Depth, (2) PC's, Printer, Internet, EPIRB
<b>Push Gear:</b>	(2) 40T Hydraulic Face Winches
<b>Other Equipment:</b>	Life Raft, Portable Dewatering Pumps, Cutting, Welding Gear, Washer, Dryer, Heat & AC

## TUG “MAME FAYE”



<b>Vessel Name:</b>	Mame Faye
<b>Class:</b>	Push Tug – Shallow Draft
<b>Port of Registry:</b>	Troy, New York
<b>Radio Call Sign:</b>	
<b>Length:</b>	26
<b>Width:</b>	10
<b>Depth:</b>	5
<b>Gross Tons:</b>	8
<b>Main Engine:</b>	Detroit 6-71
<b>Horsepower:</b>	185 HP
<b>Fuel Capacity:</b>	1,200 US Gal.
<b>Lube Capacity:</b>	15 US Gal.
<b>Electronics:</b>	(1) Radar, (2) VHF, Depth
<b>Push Gear:</b>	(2) 10 Ton Face Winches
<b>Other Equipment:</b>	Portable Dewatering Pumps, Heat



<b>Vessel Name:</b>	Margot
<b>Class:</b>	Coastal & Canal Tug – Retractable Wheelhouse
<b>Email:</b>	Tug_Margot@nysmarinehighway.com
<b>Mobile:</b>	518.469.0022
<b>Official Number:</b>	276023
<b>Port of Registry:</b>	Troy, New York
<b>Radio Call Sign:</b>	WDC-3949
<b>Length:</b>	85
<b>Width:</b>	24
<b>Depth:</b>	9.6
<b>Gross Tons:</b>	141
<b>Main Engine:</b>	Fairbanks Morse 8-38 8 1/8
<b>Horsepower:</b>	1,400
<b>Generator:</b>	(1) Detroit 20 KW AC / 30KW DC (1) Kubota 20 KW AC (1) Shaft 20 KW DC
<b>Fuel Capacity:</b>	17,000 US Gal.
<b>Lube Capacity:</b>	350 US Gal.
<b>Potable Water:</b>	3,000 US Gal.
<b>Berthing:</b>	9
<b>Electronics:</b>	(3) Radar, (3) VHF, AIS, GPS, Chart Plotter, Depth, (2) PC's, Printer, Internet, EPIRB
<b>Push Gear:</b>	(1) Hydraulic Capstan, (2) 20T Face Winches
<b>Other Equipment:</b>	Life Raft, Portable Dewatering Pumps, Cutting, Welding Gear, Washer, Dryer, Heat and AC



<b>Vessel Name:</b>	Mary Kay
<b>Class:</b>	Coastal Tug
<b>Email:</b>	Tug_MaryKay@nysmarinehighway.com
<b>Mobile:</b>	518.391.1086
<b>Official Number:</b>	554579
<b>Port of Registry:</b>	Troy, New York
<b>Radio Call Sign:</b>	WDI-9106
<b>Length:</b>	90
<b>Width:</b>	29
<b>Depth:</b>	12
<b>Gross Tons:</b>	134
<b>Main Engine:</b>	(2) EMD 12-645
<b>Horsepower:</b>	2,500
<b>Generator:</b>	(2) Detroit 40 KW
<b>Fuel Capacity:</b>	56,000 US Gal.
<b>Lube Capacity:</b>	500 US Gal.
<b>Potable Water:</b>	5,000 US Gal.
<b>Berthing:</b>	7
<b>Electronics:</b>	(2) Radar, (3) VHF, AIS, GPS, Heading Indicator, Chart Plotter, Depth, (2) PC's, Printer, Internet, EPIRB
<b>Push Gear:</b>	(1) Hydraulic Capstan
<b>Other Equipment:</b>	Life Raft, Portable Dewatering Pumps, Cutting, Welding Gear, Washer, Dryer, Heat and AC





<b>Vessel Name:</b>	Nathan G
<b>Class:</b>	Coastal Tug
<b>Email:</b>	Tug_NathanG@nysmarinehighway.com
<b>Mobile:</b>	518.903.1035
<b>Official Number:</b>	582613
<b>Port of Registry:</b>	New York
<b>Radio Call Sign:</b>	WDJ-6261
<b>Length:</b>	74
<b>Width:</b>	24
<b>Depth:</b>	8
<b>Gross Tons:</b>	162
<b>Main Engine:</b>	(2) Detroit 149
<b>Horsepower:</b>	1,200
<b>Generator:</b>	(2) Detroit 40 KW
<b>Fuel Capacity:</b>	15,000 US Gal.
<b>Lube Capacity:</b>	250 US Gal.
<b>Potable Water:</b>	3,000 US Gal.
<b>Berthing:</b>	5
<b>Electronics:</b>	EPIRB, (2) Radar, (3) VHF, AIS, GPS, Chart Plotter, Depth, (2) PC's, Printer, Internet
<b>Push Gear:</b>	(2) 40T Hydraulic Face Winches
<b>Other Equipment:</b>	Portable Dewatering Pumps, Cutting, Welding Gear, Washer, Dryer, Lift Raft, Heat and AC



<b>Vessel Name:</b>	Sarah D
<b>Class:</b>	Coastal Tug
<b>Email:</b>	Tug_SarahD@nysmarinehighway.com
<b>Mobile:</b>	518.391.1304
<b>Official Number:</b>	566998
<b>Port of Registry:</b>	New York
<b>Radio Call Sign:</b>	WDI-9093
<b>Length:</b>	90
<b>Width:</b>	29
<b>Depth:</b>	12
<b>Gross Tons:</b>	162
<b>Main Engine:</b>	(2) Caterpillar 399
<b>Horsepower:</b>	2,200
<b>Generator:</b>	(2) Detroit 40 KW
<b>Fuel Capacity:</b>	56,000 US Gal.
<b>Lube Capacity:</b>	500 US Gal.
<b>Potable Water:</b>	5,000 US Gal.
<b>Berthing:</b>	7
<b>Electronics:</b>	(2) Radar, (3) VHF, AIS, GPS, Heading Indicator, Chart Plotter, Depth, (2) PC's, Printer, Internet, EPIRB
<b>Push Gear:</b>	(2) 40T Hydraulic Face Winches
<b>Other Equipment:</b>	Life Raft, Portable Dewatering Pumps, Cutting, Welding Gear, Washer, Dryer, Heat and AC

# “GAVIN” TRUCKABLE WORK VESSEL



*NOTE: Photo shows same class/ design vessel*

- LENGTH:** 25'-3" LOA
- BEAM:** 14'
- DEPTH:** 5'
- AIR DRAFT:** Air draft in salt water  $\leq 16'6"$
- DISPLACEMENT:** 40,000 # (approx.)
- USCG EQUIPMENT:** Safety equipment, communications equipment, lifesaving, fire fighting, protection and suppression equipment, mooring lines and towing gear as required by the USCG.
- FUEL TANK:** Fuel tank capacity is approximately 500 gallons
- POWER TRAIN:** Two John Deere 6081 diesel engines, 300 HP each @ 2200 RPM (M2 rating)
- Two Twin Disc MG-5075 2.88:1 ratio.
  - Two 2 1/2" stainless steel propeller shafts with two 36" x 20" (34"x18") x 4 blade stainless steel propeller.
  - Two 2 1/2" Cutlass stern bearings.
  - Exhausts installed with "cowl" spiral exhaust silencers - Residential quiet.
- ENGINE COOLING:** Closed fresh water system circulated through 8" x 8.5 # channel welded to bottom of hull.
- ENGINE CONTROLS:** Single lever control head with heavy-duty 43C control cables.- electrically operated
- BILGE PUMP:** Two 12 volt 1,000 GPH pump.

FIRE DET/GEN ALARM: One fire detection and general alarm system

BLOWER: One 250 CFM 12 VDC blower for engine room

RUDDERS: Two independent flanking rudders with independent rudder angle indicators (RAI's)

HYDRAULIC STEERING: Two hydraulic pumps, one driven off each main engine. Control valve and flow regulator mounted in engine room.

ELECTRICAL SYSTEM: Two 12-volt heavy-duty 8D marine batteries mounted in Coast Guard approved engine room battery box.

NAVIGATION LIGHTS: Mast on top of pilot house has two white tow lights forward and two amber tow lights aft. Green and red side lights are installed on the sides of the pilot house. Mast light is detachable or hinged to lower

PILOTHOUSE: 4' 6" wide x 4' long x 6' 9" high

- One overhead cabin light.
- One 7" sealed beam searchlight and one single-bugle horn mounted on pilothouse top.
- Two six-gang 12 volt fused switch panels mounted in dash of pilothouse.
- Front window 4' x 3' horizontal slide
- Side windows are 3' x 3' horizontal slide
- Rear windows are 15" x 30" vertical slide with one of these mounted in 6' x 2' steel door
- All pilot house windows are tempered safety glass.

SHELL PLATING: Deck, sides, bottom, headlog and transom of 1/4" steel plate.

FRAMING: Deck framed with 3" x 3" x 1/4" angle on 24" centers  
Sides framed with 3" x 3" x 1/4" angle on 20" centers  
Bottom framed with 4" x 3" x 1/4" angle on 20" centers.

BULWARKS: Continuous all around hull. Bulwarks extend 14" above deck and flanged 2" built from 1/4" plate and brackets.

RUB BARS: 20' x 1/2" x 4" flat bar down each side of hull.

PUSH-KNEES: Constructed of 12" x 20.7 # channel extending 54" above deck. Push-knee braces are 1/4" steel plate finished with 3/8" x 2" flat bar. Pads are 2" thick rubber bonded to 1/2" x 10" steel backing plate

WINCHES: Two 5 ton manual winches shall be installed on the forward deck.

BITTS: One double towing bit, one single head bitt, and four single quarter bitts.-  
*NOTE: Double tow bit is thru deck and tied into bottom of hull*

LIFTING EYES: Four permanent eye straps welded to hull.

# CMI EQUIPMENT

## Truckable Work Vessel

**MAKE:** Lifeyme 30' Landing craft with Cabin (Model 30120)

### **SPECIFICATIONS:**

- \*30' LOA plus motor bracket
- \*120" Beam
- \*No bow door add front deck
- \*Fuel Capacity: 120 gallons
- \*.250" 5086-H116 bottom plating
- \*.190" 5052 side plating
- \*.190" 5052-H32 deck plating
- \*Centerline vertical keel (CVK): 3/8"X4" 5086

### **HULL PACKAGE:**

- \*30' high speed mono hull landing craft incorporating 1/4" hull plating & framing
- \*Hull will have 2 structural bulkhead; forward collision bulkhead watertight; the aft bulkhead limbered for drainage via bilge pump
- \*Transom will be designed for 25" shaft outboard motors with a motor bracket
- \*1/2" aluminum double padeye will be welded on center of the bow
- \*Duel gill bracket for engines
- \*Motor cage around engines
- \*4-T-cleats
- \*4-Lifting eyes (Pick-up boat)
- \*Tow bit
- \*Anode

### **WELDING:**

- \*Hull and superstructure will be constructed of marine grade aluminum and MIG welded throughout.
- \*Weld seams in the hull will be welded 100% both interior & exterior
- \*Welding will be performed in accordance with American Welding Society D1.2-2003 procedure qualifications

### **HULL OUTFITTING:**

- \*4-2"X7" open scuppers at midship, pipe drains in the stern and 2-1" pipe drains at the bow will create a self-bailing Main deck. Drains and scuppers will be sized & Installed in accordance with ABYC deck drainage requirements.
- \*1/4"X4" beaching wear plate installed on bow forefoot
- \*DB 503 3" D-rubber fender will be installed on the gunwale, port and starboard side
- \*1-15"X24" aluminum hatch watertight
- \*Push-bumpers

### **FUEL SYSTEM:**

- \*120 gallons non-integral fuel tank installed complete with fill, vent, 12V sender and fuel level gauge on console
- \*Fuel tank will be built from 1/4" plate, pressure tested to 4 psi and bolted into hull framing using doublers and stainless steel fasteners.
- \*Fuel system will comply with U.S. diurnal emission standards
- \*EPA certified fuel system
- \*Fill and Vent

\*1-Fuel gauge

\*2-Fuel filters

**CABIN:**

\*10'X9', 1-front door, 2-sliders, rubber windows

\*2-Captain seats

\*1-bench seat across back of cabin with cushions/dry storage

\*1-bench seat on starboard with cushions/dry storage

\*1-bench seat on portside with cushions/dry storage

\*Insulated cabin roof and sidewalls (Floor to bottom of windows)

\*Air conditioner with heater

\*Honda generator si3000 watts

**TRIM TABS:**

\*9"X18" Lenco Electric trim tabs

**PAINT:**

\*Anti-fouling on hull bottom

\*Non-skid tape on deck floor

**ELECTRIC SYSTEM:**

\*Vessels electrical system will be 12VDC. All electrical cable will be marine grade copper tinned boat cable and labeled for each circuit. Cables should be routed in wireways wherever possible. Wherever exposed to potential damage, cables will be protected with rubber. Electric cables will be sized in accordance with American Boat & Yacht Council. Electric cables will be marked in accordance with the markings in electrical drawings. Electrical switches will be of a heavy-duty type and properly insulated. Electrical system will be grounded. In any case the hull shall not be used as part of a galvanic feeding loop.

**RADAR:**

\*GARMIN GPSMAP 743xsv US+Canada GN+w/18HD+Bundle 010-02365-80

\*AIRMAR B60-20-MN, Bronze low profile 20 degree tilt, mix and match transducer

\*AIRMAR MM-8G, 8-Pin mix and match cable for B60MM Garmin

\*2-Standard Horizon Eclipse VHF radio with antennas

**12V DC ACCESSORIES:**

\*1-12V 8 position waterproof distribution panel installed on console

\*1-12V power receptacle will be installed with weather cover

\*1-12V 2200 GPH bilge pump auto-matic

\*2-12V self-parking windshield wiper will be installed on the front window

\*1-12V Electric horn

\*2/2Batteries/plastic cases for engine starting bank, 2-batteries selector switches

**STEERING SYSTEM:**

\*Hydraulic steering dual Teleflex, stainless steel steering wheel

**LIGHTING:**

\*Navigation Lights will be installed to USCG requirements

\*1-Dome light ( red/white)

\*2-dome light (white)

\*2-L.E.D. deck lights

\*1-Searchlight remote control

**MOTORS:**

\*2-150HP Honda, dual top mount control, dual key switch, wiring harnesses, 2-tach gauges, 2-stainless steel propellers

**TRAILER:**

\*Aluminum triple axles with brakes on two axle, CAP#15,000 lbs.,

**SEA TRAILS:**

\* Sea trails

# "JORY"



# CMI Equipment

## Cable Lay Support Vessels

**Manufacturer: Carolina Skiff**

### **FL-540 Specs**

- Length-21'2"
- Beam-98"
- Draft-6"
- Max HP-115
- Max persons-12
- Max capacity-2405lbs
- Weight-1600lbs

### **FL-541 Specs**

- Length-27'1"
- Beam-98"
- Draft-5"
- Max HP-200
- Max persons-12
- Max capacity-3405lbs
- Weight-2400lbs



**Appendix 2 - CMI Shear / Jet Plow**

# *Caldwell*

Marine International  
a JAG Company

## Caldwell Marine International LLC.

### Cable Installation Equipment Shear/Jet-Plow



**Presented by:**

Caldwell Marine International, LLC  
1333 Campus Parkway, Wall Township, NJ 07753  
Phone (Office): (+1) 732 557 6100  
Web Page: [caldwellmarine.com](http://caldwellmarine.com)

REVISIONS				
REV #	DESCRIPTION	AUTHOR	APPROVAL	DATE OF ISSUE
0.0	INTERNAL REVIEW	PS		07/27/2020
1.0	ISSUE TO CLIENTS	PS		12/04/2020

## Table of Contents

1	Introduction .....	3
2	Vehicle Dimensions / Weight.....	4
3	Vehicle Launch & Recovery .....	4
4	Loading / Unloading Cable Product .....	4
5	Plow / Lay Barge Connections .....	4
6	Vehicle Data Monitoring & Recording .....	6
7	Vehicle Customization .....	13
7.1	Blade Modifications .....	13
7.2	Optional Belly Pan .....	14
8	Jet-Trenching Theory .....	15
9	Typical Jet-Trench Profile .....	16

## Table of Figures

Figure 1 - Plow Umbilical (Primary + Spare) .....	5
Figure 2 - Home Screen - Plow Control System .....	6
Figure 3 - Surveillance Page - Plow Control System .....	7
Figure 4 - Logging Page - Plow Control System.....	8
Figure 5 - Logging Trend Selection Page - Plow Control System .....	9
Figure 6 - Network Diagnostics Page - Plow Control System .....	10
Figure 7 - Settings Page - Plow Control System .....	11
Figure 8 - View Strings Page - Plow Control System .....	12
Figure 9.-.Dual Chamber Jetting Blade - shown with upper & lower nozzle arrays.....	13
Figure 10 - Plow Configured With Belly Pan .....	14
Figure 11 - Typical Trench Profile (2.58m length blade).....	16

## **1 Introduction**

*Caldwell Marine International* (CMI) maintains an extensive inventory of submarine cable installation & repair equipment. Our primary burial tool is a Shear/Jet-Plow, we utilize this vehicle for projects requiring simultaneous lay & burial operations.

The vehicle was designed by Engineering Technology Applications (ETA) Ltd, U.K. and was built under license in the USA. CMI has employed this vehicle on multiple projects with great success.

## **2 Vehicle Dimensions / Weight**

Plow Length:	~35ft (~10.67m)
Plow Width:	~15ft (~4.57m)
Vehicle Overall Height (with 1.2m blade raised):	~16ft 6" (~5.0m)

## **3 Vehicle Launch & Recovery**

Plow design incorporates four lifting points that enable launch and recovery of the vehicle using a rated wire bridle suspended from (a) deck crane, or (b) 'A' frame with suspended sheave.

## **4 Loading / Unloading Cable Product**

Cable product is loaded / unloaded by divers. Rollers in the forward cable feed area can be opened to enable the product to be easily inserted and secured. The vehicle's burial blade is equipped with hinged doors that open to generate a wide aperture. Divers verify that loading doors are securely and properly, closed on completion of the product loading process

CMI maintains a core team of experienced professional divers who are well versed in plow operations. In addition to the described plow load / unload functions, the plow design incorporates extensive use of wet mate-able connections; this enables diver change-out of key componentry without the need for vehicle recoveries and their associated plow-skip areas

## **5 Plow / Lay Barge Connections**

The CMI Shear/Jet Plow is tethered to the surface lay vessel by the following connections:

1. Tow wire – Tow wire pay-out / pay-in is controlled by a tow winch and is outfitted with a dynamometer that feeds tension data to CMI's lay computer. Deck operators can adjust vehicle layback distance in accordance with water depth and other prevailing conditions
2. Water Hose(s) – Jet nozzle arrays on the vehicle are fed via, one or more, pressurized raw water hoses connected surface-supply pump(s). The number of hoses employed will be dictated by seabed conditions, depth of burial requirements, and whether a high / low pressure combination is required. Topside pressure sensors enable operators to adjust pump output(s) to optimal level(s)
3. Cable product – Cable feed rate is controlled by barge mounted Linear Cable Engine(s) (LCE). Cable payout is adjusted as necessary to maintain an 'ideal catenary' in accordance with barge forward progress and changes in route bathymetry
4. Crane lift (optional): - Crane assist may be employed in special circumstances e.g. utility crossings. A crane hook is attached to the vehicle recovery lift point via rated rigging
5. Umbilical – The vehicle is outfitted with two identical umbilicals (primary + spare) – See *Figure 1*

Umbilical specifications (each) as follows:

- a. Length 492ft (150m)
- b. Umbilical diameter 0.73 inches (18.5mm)

# *Caldwell*

## Marine International

a JAG Company

- c. Cable componentry: Six x 2.5mm cores, Five x 0.75mm screened twisted pairs, Type 1582 cable
- d. Terminations (a) Subconn MCOM21F (wet-mateable), DLSB-F (topside)



*Figure 1 - Plow Umbilical (Primary + Spare)*

## 6 Vehicle Data Monitoring & Recording

The CMI Shear/Jet Plow was updated in 2020 with a new vehicle control system that was designed & programmed by Osbit Ltd., UK. Other 2020 updates included:

- a. Two new stainless steel depth rated subsea electronics pods (primary + spare)
- b. Two new umbilical cables (primary + spare)

The new control system features the following 'user selectable' screens:

- Home Page – See Figure 2
  1. Jetting water pressure monitoring @ Topside Manifold / Blade Chambers
  2. Vehicle Pitch / Roll Heading
  3. Tow wire out / Tow Wire Tension / Cable Out / Cable Tension / Cable Angle (departure) / Vessel Heading (degrees)
  4. Alarm Code / Time / Date / Description

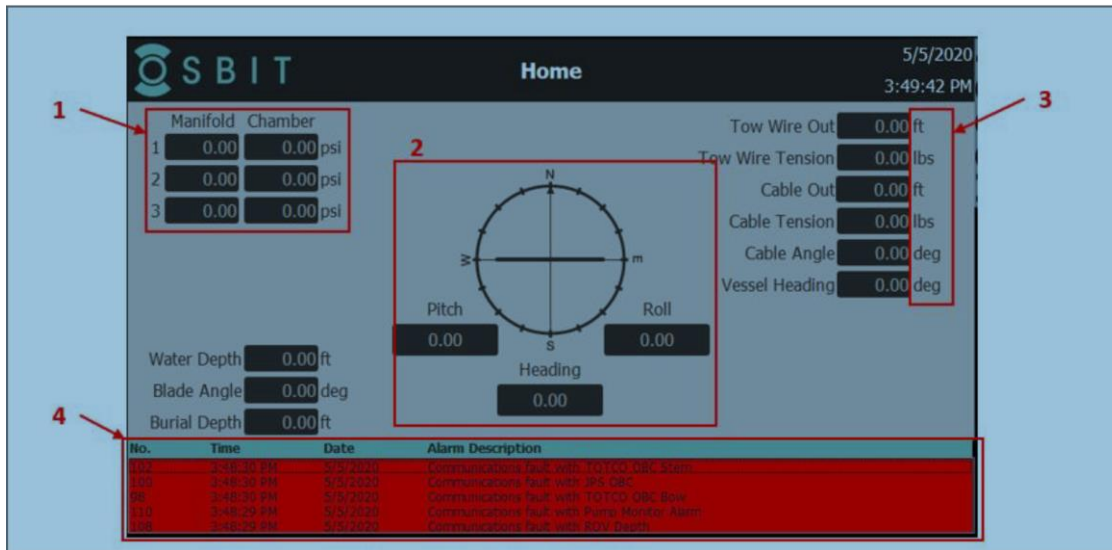

Figure 2 - Home Screen - Plow Control System

- Surveillance Page – See Figure 3
  1. Gyro / Sonar
  2. Camera control
  3. Lamp Selector On/Off / Dim

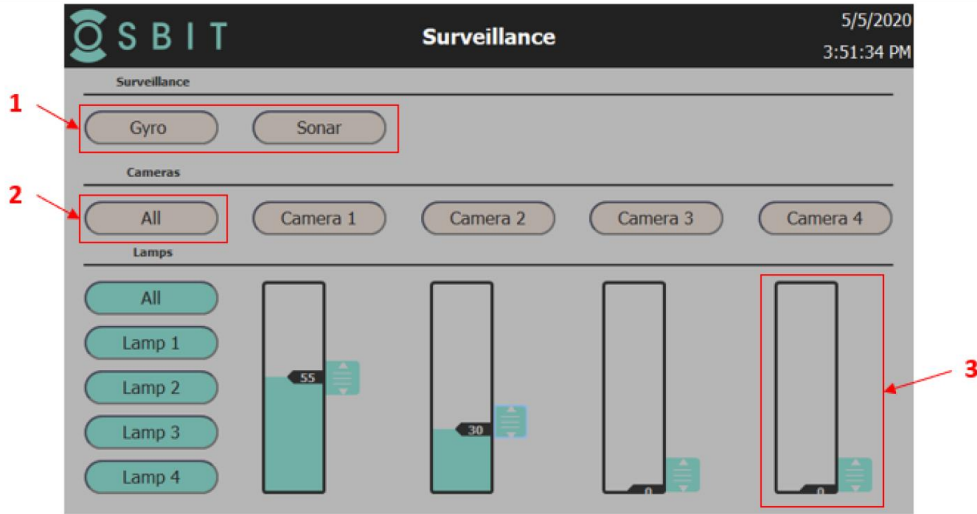

Figure 3 - Surveillance Page - Plow Control System



- Logging Page – See Figure 4
  1. Trend view inspector window - The trend view provides a graphical representation of tag values from the selected processes
  2. Navigation Toolbar – allows user to alter the trend view in the inspector window
  3. Ruler Toolbar - allows user to utilize the ruler functions the in the inspector window
  4. Trend tabular summary - Displays the line colour, trend name, value and date / timestamp of the selected trends
  5. Select trend button - Select to open the logging trend selection page
  6. Selected trends feedback - Displays the currently selected feedback allocated to each trend line

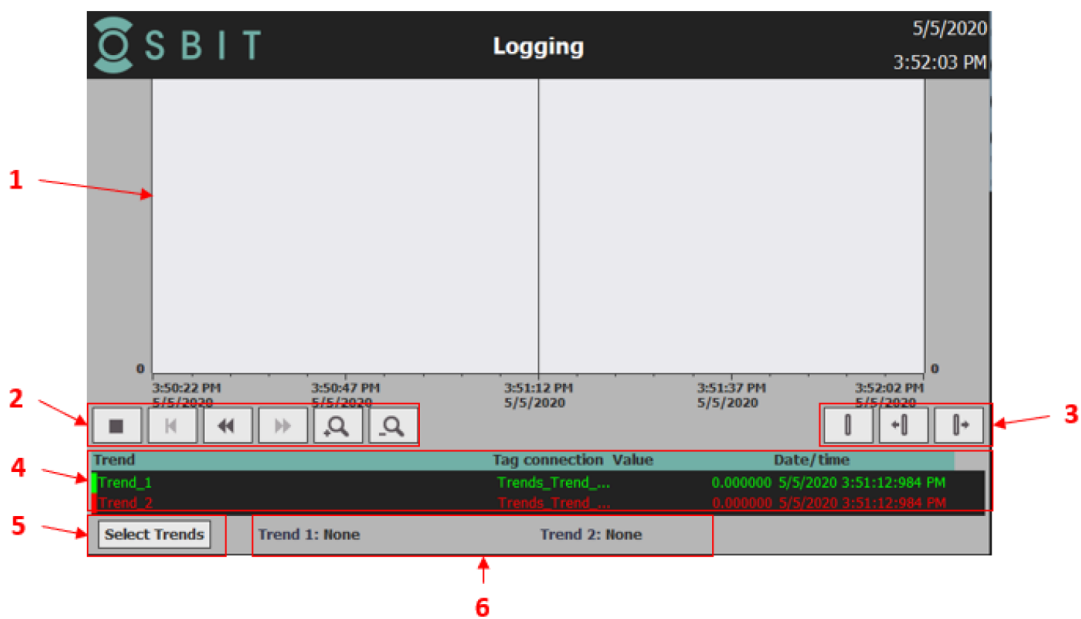

Figure 4 - Logging Page - Plow Control System

- Logging Trend Selection Page – See Figure 5
  1. Trend selection menu - Click the dropdown menu to open the dropdown menu and display values available for plotting
    - Up to 2 trends can be selected simultaneously
  2. Close button – Click to close window and navigate back to logging page

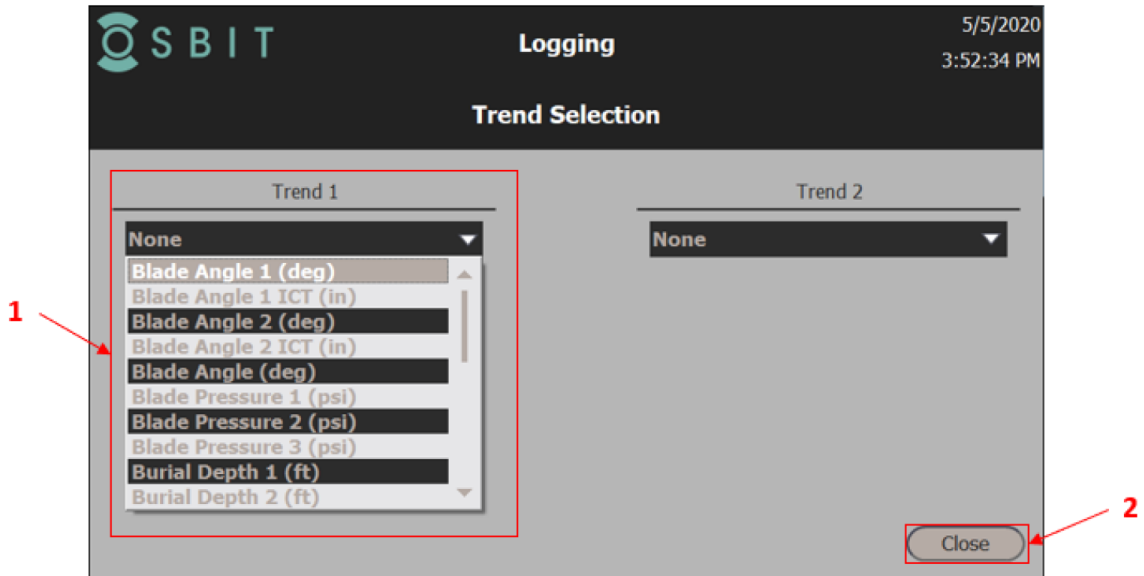

Figure 5 - Logging Trend Selection Page - Plow Control System

- Network Diagnostics Page – See Figure 6
  1. Network Overview Window - Displays network detail. Click line items to select and then use the navigation menu to toggle through levels of detail.
  2. Navigation Toolbar - Use this menu to navigate through various levels of details of the network

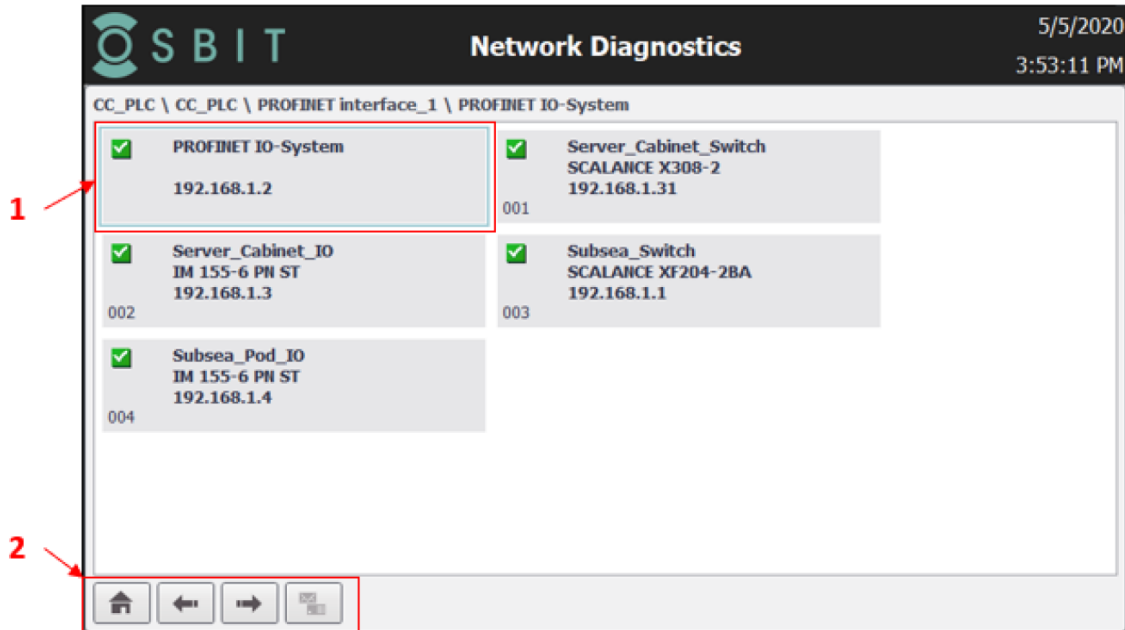

Figure 6 - Network Diagnostics Page - Plow Control System

- Settings Page – See Figure 7
  1. View String Buttons - Click to open the corresponding view string page
  2. Settings Button – After selection of device, click to view data string view page
  3. Blade Angle Port / Starboard Selection - Click to select either port or starboard cylinder as the primary data source for burial depth and blade angle
    - When selected the corresponding button LED is illuminated as shown above
    - **NOTE:** Either blade angle ICT may be selected with the vehicle subsea providing a degree of redundancy during operations
  4. Lamp trim settings button – Click to open lamp trim settings page
  5. PLC web server button – Click to open the PLC web server in a new window

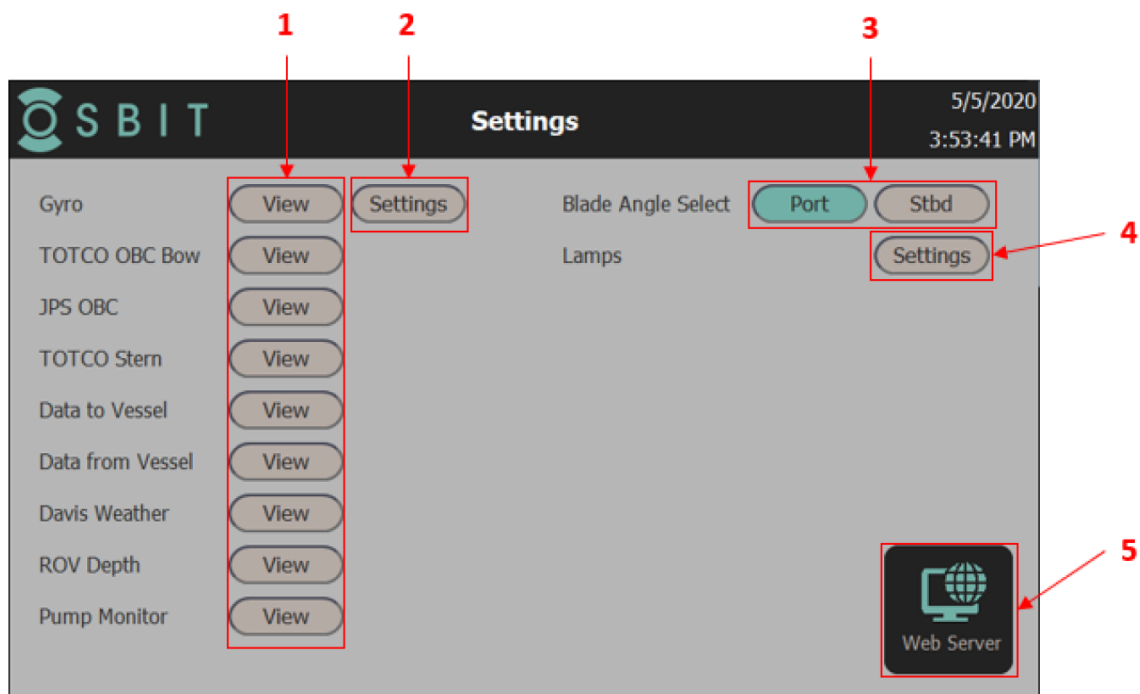

Figure 7 - Settings Page - Plow Control System

- View Strings Page – See Figure 8
  1. String Selection Dropdown Menu - Click to open up the dropdown menu and select which string to view in the buffer below
  2. String Buffer Window - Updates in real time to display the current incoming or outgoing raw string detected at the RS232 module
  3. Close Button - Click to close the window and navigate back to the settings page

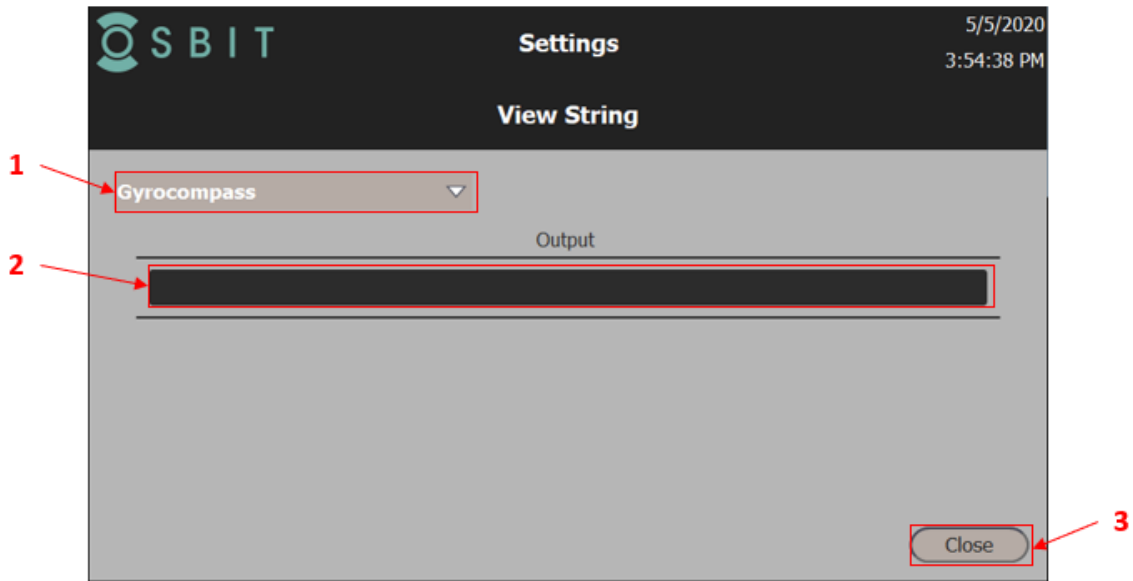

Figure 8 - View Strings Page - Plow Control System

## 7 Vehicle Customization

The plow can be custom configured in accordance with site-specific conditions and product handling requirements. Vehicle customization tasks are performed at our fully equipped fabrication facility, located in southern New Jersey.

### 7.1 Blade Modifications

- Blade design can be altered to accommodate products of differing dimensions
- Blade length can be configured to achieve the Client specified depth of burial. **NOTE:** *To date we have successfully used our jet plow to lower power cables from as little as 4 feet (~1.2m) to as much as 15 feet (~4.5m) below seabed grade level*
- Water jet design, count and distribution can be configured to suit specific soil conditions and to minimize local turbidity. If necessary, blade design can incorporate multi-chambers to further improve burial efficiency and minimize the potential for environmental impact

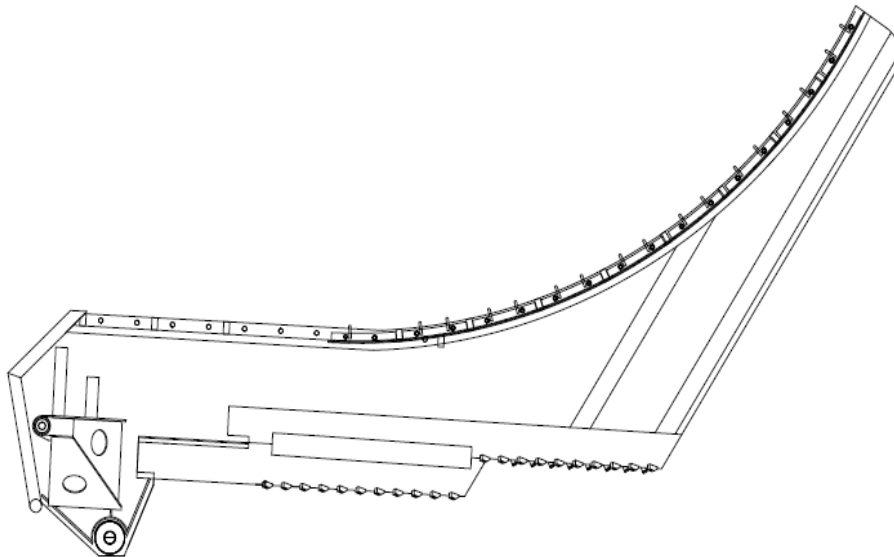

Figure 9.-Jetting Blade - shown with upper & lower nozzle arrays (Sample)

## 7.2 Optional Belly Pan

- For soft soil conditions, the vehicle can be outfitted with a 'belly plate' to minimize the unit pressure imparted on the seabed and thereby reduce vehicle sinkage, and skid depression depth.

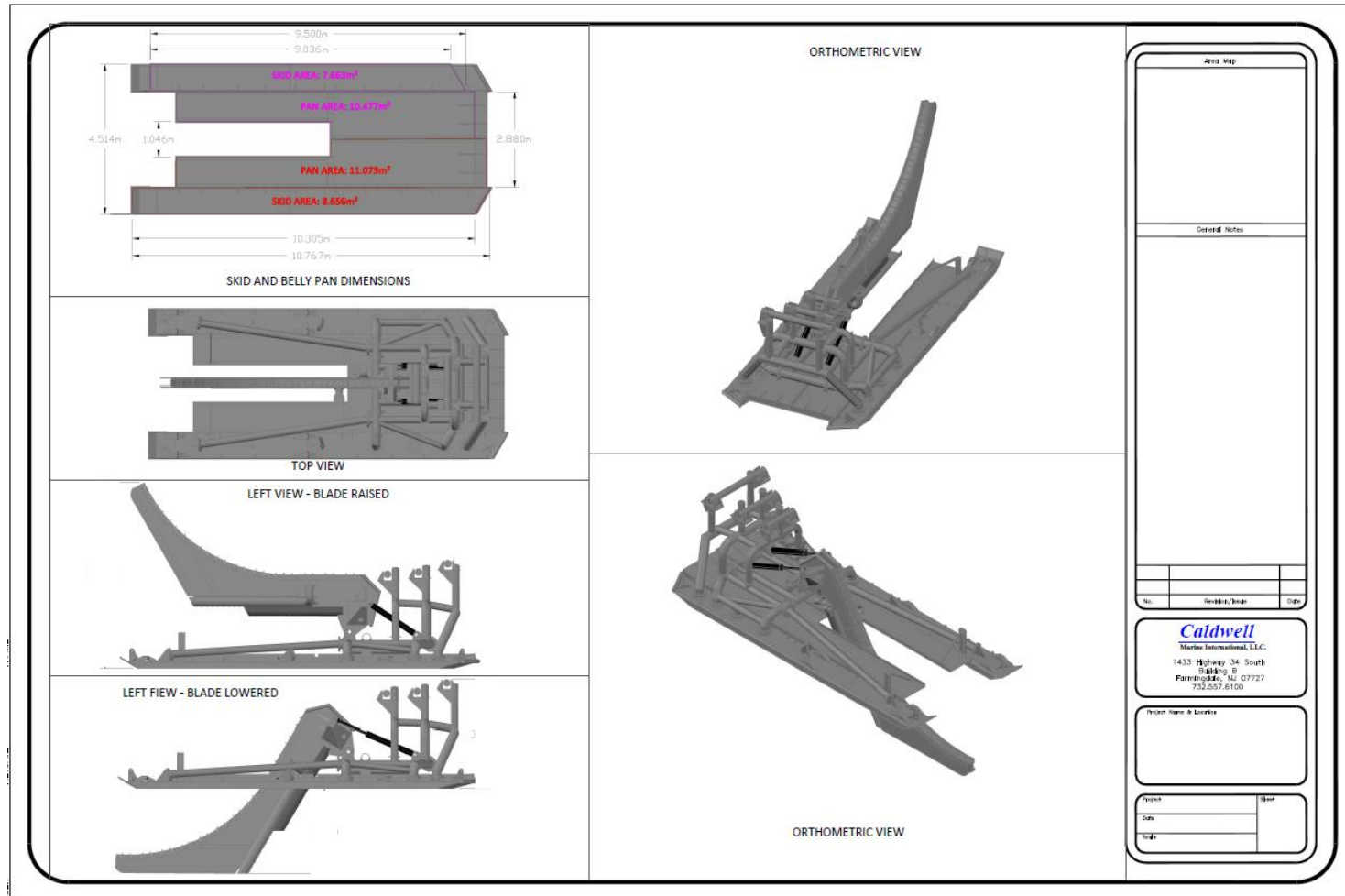

Figure 10 - Plow Configured With Belly Pan

## **8 Jet-Trenching Theory**

Jet plow trenching blades are specifically configured for each cable project. The water nozzles inject water to fluidize the substrate immediately ahead of the blade. This process results in reduced plow tow tension.

As the plow is towed forward, the cable feeds through the plow blade until it exits the base aperture. The plow continues its advance, leaving the cable embedded into the sea floor at blade penetration level. The recently fluidized seafloor material quickly precipitates out to fill the void astern of the vehicle. Subsequent inspection of the installation route will typically reveal very little evidence of recent burial activities except, perhaps, a minor seabed depression.

CMI plow operators will typically seek to maximize plow advancement rate. Our experience has indicated that increased installation rates serve to further minimize local impacts. If circumstances should require temporary stoppage of lay / burial activities, the water pump output will be reduced to the minimum required to keep jets unclogged. Lay / burial pump pressures will be restored and forward progress resumed once the situation has been satisfactorily resolved.



**9 Typical Jet-Trench Profile**

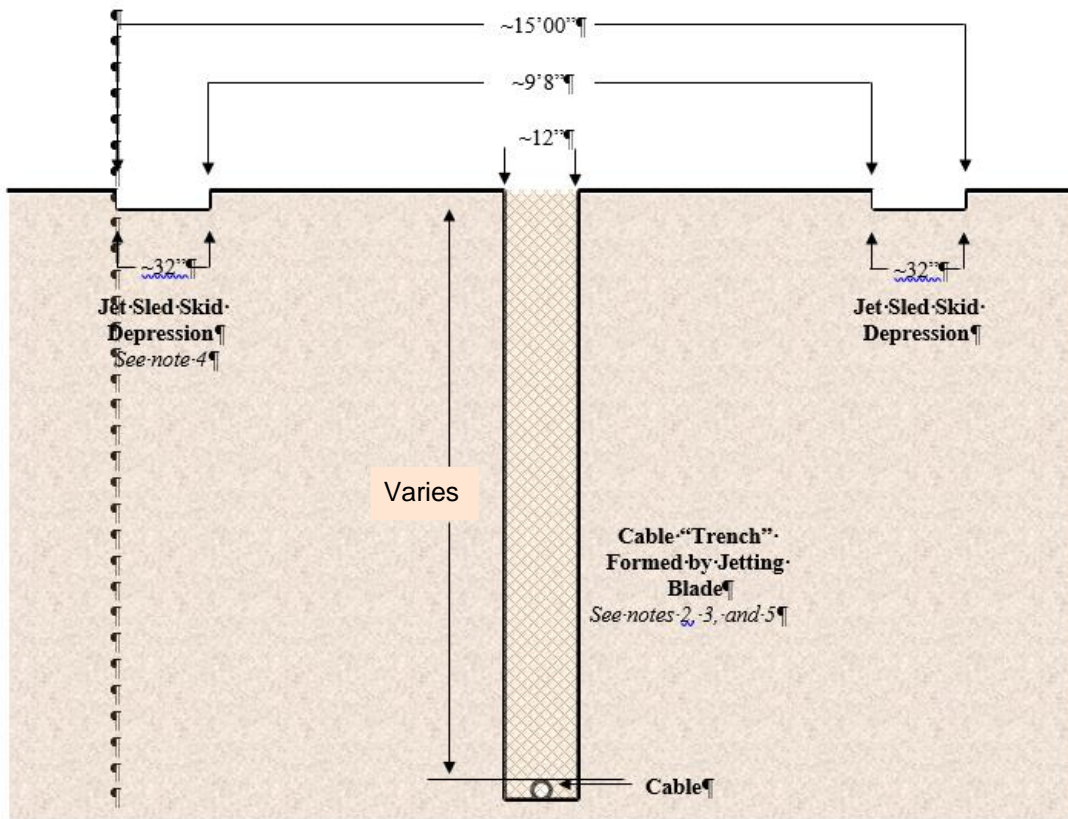

Figure 11 - Typical Trench Profile (2.58m length blade)

**NOTES:**

1. Drawing is not to scale.
2. Trenching depth of lowering expected to 4 ft (1.2m)
3. Final Trenching depth achieved is dependent upon substrate composition. Particle size, soil homogeneity etc., may impact overall vehicle performance.
4. Depending on the density of the seabed, the area disturbed by the jet sled skids may be exaggerated in the provided depiction. Jet sled skids have been designed to evenly disperse the weight of the plow. Actual vehicle sinkage is typically minimal.
5. The depth of trenching achieved is principally dependent upon the length of the vehicles plow blade and its deployment angle. Plow share penetration depth is controlled by hydraulic rams which articulate the plow share in an arc relative to the vehicle chassis. Penetration depth will typically be adjusted during periods of plow grade-in and grade out where a gradual arc is required to conform to product minimum bending radius requirements. During such times the jet power will be user adjusted and kept to the minimum required to successfully complete the grade-in process.